

Nice

CE

MINDY A400

Control unit

EN - Instructions and warnings for installation and use

IT - Istruzioni ed avvertenze per l'installazione e l'uso

FR - Instructions et avertissements pour l'installation et l'utilisation

DE - Installierungs-und Gebrauchsanleitungen und Hinweise

ES - Instrucciones y advertencias para la instalación y el uso

PL - Instrukcje i ostrzeżenia do instalacji i użytkowania

www.latmet.com

SIA Lat Met: Reģ. Nr. LV 44103033222

“Meistari”, Kocēnu novads,

Kocēnu pagasts, Latvija, LV4220

Tālrunis: +371 642 29800; E-pasts: info@latmet.com

Nice

mindy A400

Table of contents:

	pag.		pag.
1	3	4	10
Product description		Programming	
2	3	4.1	10
Installation		Memory deletion	
2.1	3	4.2	10
Preliminary checks		Programming methods	
2.2	4	4.2.1	11
Fixing the A400 control unit		Level one programming: functions	
2.3	4	4.2.2	11
Typical system layout		Level two programming: parameters	
2.4	4	4.2.3	12
Electrical connections		Example of level one programming	
2.4.1	5	4.2.4	12
Electrical diagram		Example of level two programming	
2.4.2	5	4.2.5	13
Description of connections		Programming diagram	
2.4.3	6	5	14
Notes on connections		Testing	
2.4.4	6	6	14
Phototest		Optional accessories	
2.4.5	7	7	14
Checking connections		Servicing the A400 control unit	
2.5	7	7.1	14
Searching for mechanical stops		Disposal	
2.5.1	8	8	15
Automatic searching		What to do if ...	
2.5.2	8	9	15
Searching with the current sensitivity device disabled		Technical specifications	
3	9	Annex:	
Programmable functions		SMXI Radio receiver	16
3.1	9		
Pre-set functions			

Avvertenze:

⚠ This manual has been especially written for use by qualified fitters. No information given in this manual can be considered as being of interest to end users! This manual refers to the A400 control unit and may not be used for different products.

The A400 control unit has been designed to control electromechanical actuators for automated swing gates or doors; any other use is considered improper and is consequently forbidden by current laws. Do not install the unit before you have read all the instructions at least once.

1) Product description:

The A400 control unit operates on the basis of a system (current sensitivity) which checks the load of the motors that are connected to it. This system automatically detects the travel stops and recognises obstacles during normal movement (anti-crush safety feature).

This feature makes installation very simple given that no adjustments need to be made.

The control unit is pre-programmed for normal functions while more specific functions can be chosen following a simple procedure.

 The level of current also depends on other factors apart from load, e.g.: voltage variations, the type of motor, the value of the starting capacitor, etc... The A400 control unit has been optimised for the motors used in the Wingo actuators, other types of motor may cause the A400 control unit to work incorrectly.

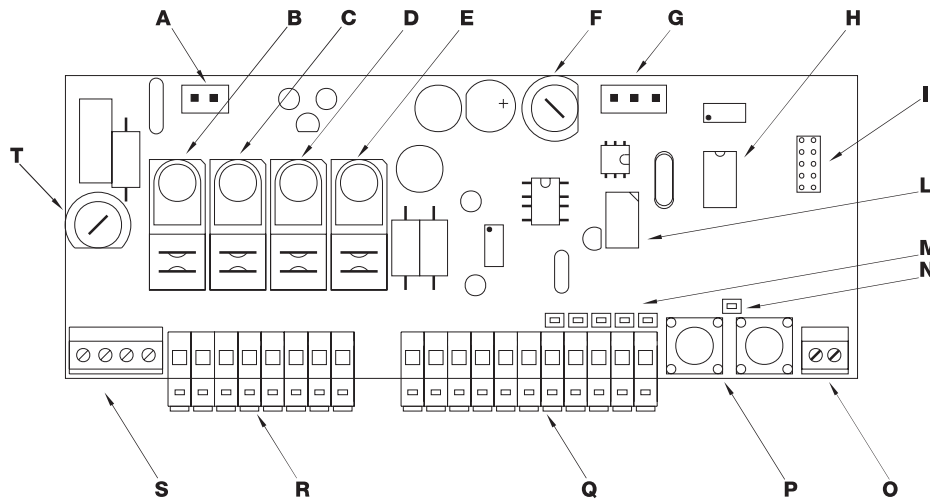

- A** Primary transformer connector
- B** Common relay
- C** Open/Close relay
- D** M1 motor relay
- E** M2 motor relay
- F** Very low voltage fuse (500mA)
- G** Secondary transformer connector
- H** Microprocessor
- I** Radio receiver connector
- L** Phototest relay
- M** "INPUTS" Led
- N** "OK" Led
- O** Terminal for radio aerial
- P** Programming buttons
- Q** Input-output terminals
- R** Terminals for motors and flashing light
- S** Power input terminals
- T** Line fuse (5A)

⚠ In order to protect the operator and the electronic card from accidental damage, only the control unit terminal boards and programming buttons are normally accessible.

Only remove the cover if necessary and always disconnect the mains power supply beforehand.

2) Installation:

⚠ Automatic gate and door systems may only be installed by qualified fitters in the full respect of the law.

Comply with the warnings shown in the "Warnings for fitters" file.

2.1) Preliminary checks

Before starting installation make sure that all the material is suitable for installation and complies with legal requirements. As well as checking all the points shown in the "Warnings for fitters" file, this section also contains a specific check list for the A400 control unit.

- The "mechanical stops" must be able to stop the gate from moving and must absorb all the kinetic energy accumulated during movement without difficulty.
- Power the control unit using a 3 x 1.5 mm² cable.
Should the distance between the control unit and the earth connection exceed 30 m, install an earth plate near the control unit.
- Use wires with a minimum cross section of 0.25 mm² to connect low voltage safety circuits.
Use shielded wire if the length exceeds 30 m and connect the earth braid only on the control unit side.

- Do not connect cables in buried boxes even if they are completely watertight.
- If correctly installed, the control unit is protected to IP55 and can therefore be installed outdoors.
Fix the control unit on a permanent surface that is perfectly flat and adequately protected against knocks, making sure that the bottom remains at least 40 cm from the ground.
- Only fit cable holders or pipe leads in the lower part of the container (**see figure 1, figure 1a**).

2.2) Fixing the A400 control unit

The container is fitted with a cover which protects the electronic board from accidental contact.

Only touch the board when necessary by proceeding as shown in **figure 1a**.

To make it easier to make holes in the lower part of the container, lower the plastic bottom as shown in **figure 1a, ref. 1**.

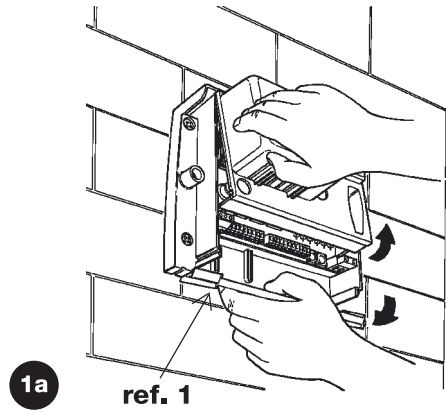
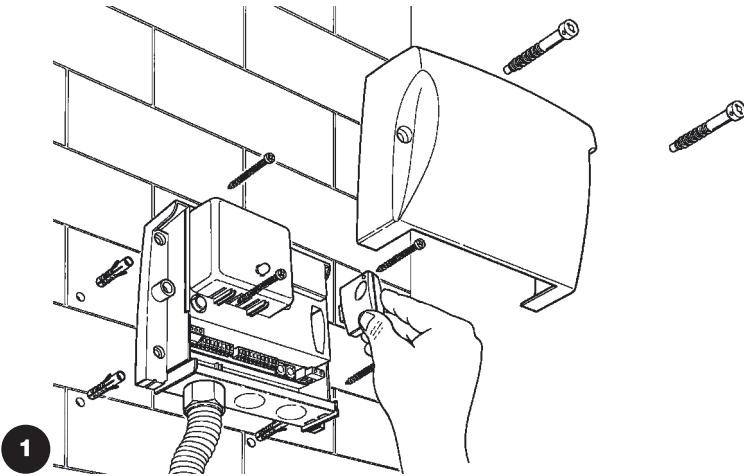

2.3) Typical system layout

In order to explain certain terms and aspects of an automatic 2-leaf swing door or gate system, we will now illustrate a typical system layout.

In particular, please note that:

- All the photocells produced by NICE feature the SYNCHRONISM system which eliminates the problem of interference between two pairs of photocells (please consult the photocell instructions for further details).
- The "PHOTO" pair of photocells have no effect during opening while they invert movement during closing.
- The "PHOTO1" pair of photocells stops both the opening and closing manoeuvres.
- The "PHOTO2" pair of photocells (connect to the suitably programmed AUX input) have no effect during closing while they invert movement during opening.

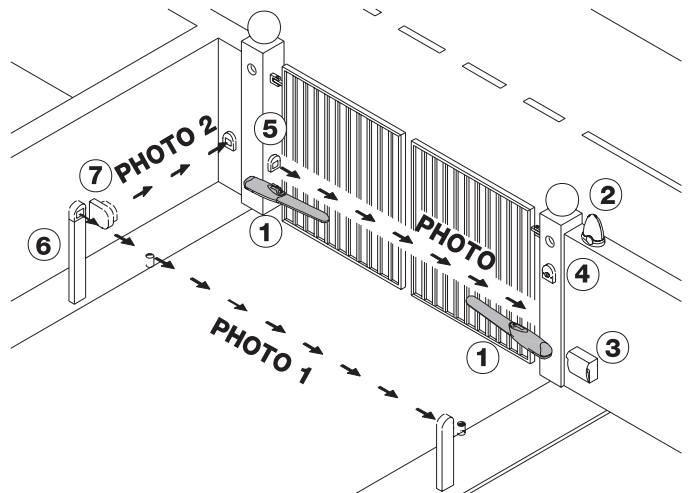

- | | |
|--------------------------------|--------------------------------|
| 1. Elettromechanical actuators | 5. "PHOTO" pair of photocells |
| 2. Flashing lamp | 6. "PHOTO1" pair of photocells |
| 3. "A400" control unit | 7. "PHOTO2" pair of photocells |
| 4. Key switch | |

2.4) Electrical connections

⚠ To protect the fitter and avoid damaging the components while electrical connections are being made or the radio receiver is being connected, under no circumstances may the unit be electrically powered.

- If the inputs of the NC (Normally Closed) contacts are not used they should be jumped with the "24V Common" terminal (except for the photocell inputs; for information please see the PHOTOTEST function).
- If there is more than one NC contact on the same input, they must be connected in SERIES.

- If the inputs of the NO (Normally Open) contacts are not used they should be left free.
- If there is more than one NO contact on the same input, they must be connected in PARALLEL.
- The contacts must be mechanical and potential-free; no stage connections are allowed, such as those defined as "PNP", "NPN", "Open Collector", etc..
- The starting condenser is built into the WINGO motors.

2.4.1) Electrical diagram

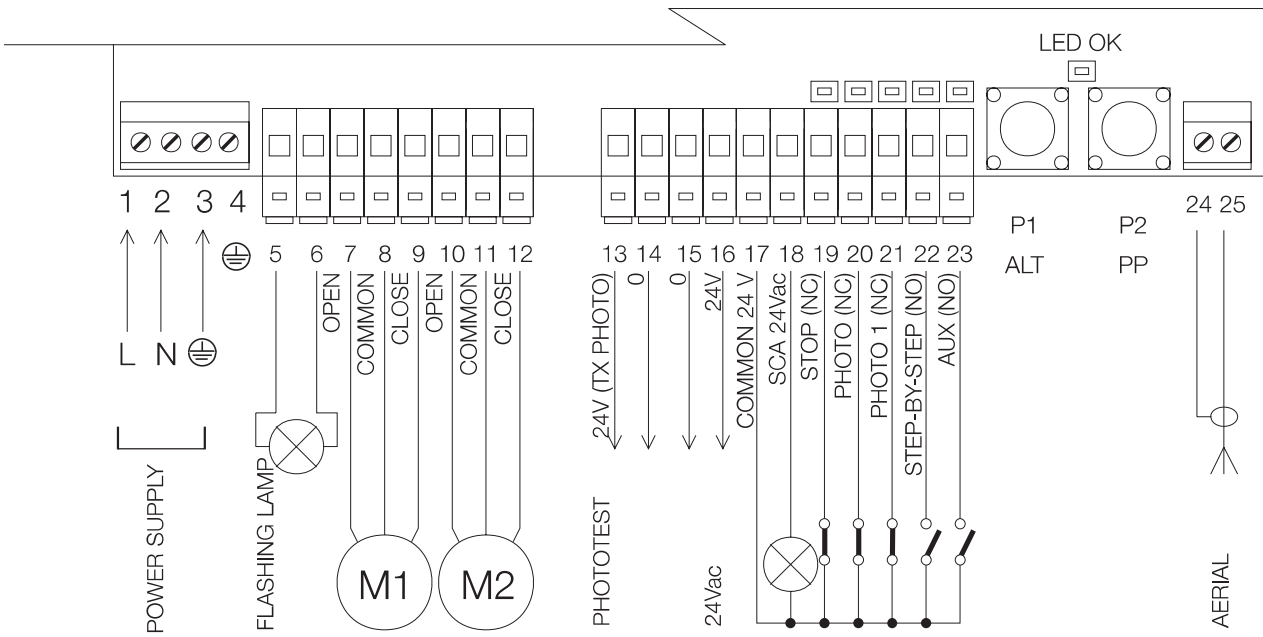

WARNING: Connection of photocells with Phototest (see chapter 2.4.4)
Note: pre-programmed control unit set for automatic measuring of working time (see chapter 2.5.1)

2.4.2) Description of connections

A brief description of the possible control unit output connections follows

Terminals	Functions	Description
1÷3	Power input	Mains power supply
4	Earth	Motor earth connection
5	Flashing lamp	Connection of flashing lamp to mains voltage (max. 40W)
7÷9	Motor 1 *	M1 motor connection (lower leaf)
10÷12	Motor 2 *	M2 motor connection (upper leaf)
13÷14	Phototest	TX photocell power output (24Vac max. 100mA)
15÷16	24 Vac	Power output for services, RX photocells, etc. (24Vac max. 150mA)
17	Common 24 Vac	Common for all inputs/outputs
18	SCA	Gate open indicator (24Vac max. 1.5W)
19	Stop	Input NC with STOP function (emergency, safety shutdown)
20	Photo	Input NC for safety devices (photocells, pneumatic edges)
21	Photo1	Input NC for safety devices (photocells, pneumatic edges)
22	Step-by-Step	Input for cyclical functioning (OPEN STOP CLOSE STOP)
23	AUX	** Auxiliary input
24÷25	Aerial	Input for the radio receiver aerial

* With 2 motors, the first to move in the opening cycle is the M2 motor.

The A400 control unit automatically recognises if there is just one motor installed which must be connected to M2.

** The auxiliary input AUX may be programmed in one of these functions (see chapter 4 "Programming"):

Function	Input type	Description
PARTIAL OPEN type 1	NO	Completely opens the leaf connected to the M2 motor
PARTIAL OPEN type 2	NO	Opens the 2 leafs halfway
OPEN	NO	Only carries out the open manoeuvre
CLOSE	NO	Only carries out the close manoeuvre
PHOTO 2	NC	PHOTO 2 function
DISABLED	--	No function

Unless otherwise programmed, the AUX input performs the PARTIAL OPEN type 1 function

2.4.3) Notes about connections

Most connections are extremely simple; many of them are direct connections to a single user point or contact. The following figures show examples of how to connect external devices.

Gate open indicator connection

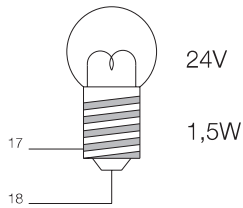

Slow flashing means the gate is opening.
Fast flashing means the gate is closing
Lamp permanently on means the gate is open.

Connections for an external radio

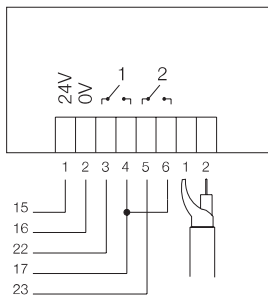

Example of connection for a 24Vac powered external radio.
Channel 1 → STEP-BY-STEP
Channel 2 → AUX

Key switch connection

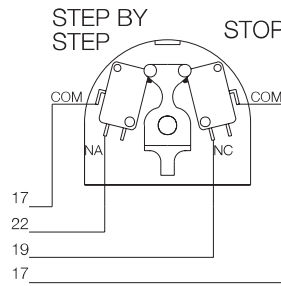

Example 1

How to connect the switch in order to perform the STEP-BY-STEP and STOP functions.

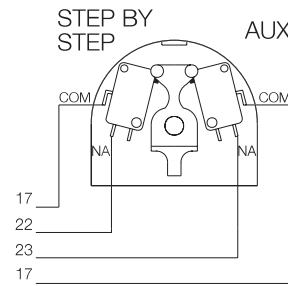

Example 2

How to connect the switch in order to perform the STEP-BY-STEP function and one of the auxiliary input functions (PEDESTRIAN, OPEN ONLY, CLOSE ONLY...).

2.4.4) Phototest

The PHOTOTEST function is a **standard** feature on the A400 control unit. This is an excellent solution as regards the reliability of safety devices and puts the control unit and safety devices into "category 2" as per UNI EN 954-1 standard (ed. 12/1998).

Whenever a manoeuvre is begun, the relative safety devices are checked and only if everything is in order will the manoeuvre start. All this is only possible if a special configuration of the safety device connections is used; in practice, the "TX" photocell transmitters are powered separately from the "RX" receivers.

The SYNCHRONISM function (available on all NICE photocells) is the only way of ensuring that two pairs of photocells do not interfere with each other.

The inputs subject to the phototest procedure are PHOTO, PHOTO1 and the AUX input if configured as PHOTO2. The Phototest phase takes place at the beginning of each manoeuvre and cannot be disabled; therefore, if one of these inputs is not used, it must be connected to terminal n°13, please consult the following figures for examples of connections.

Photo, photo1 and photo2 connection diagram.

Connection diagram with just the PHOTO photocell

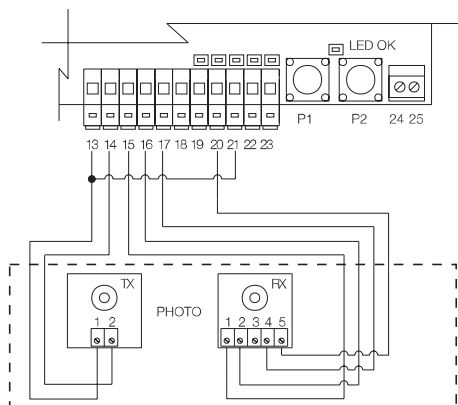

2

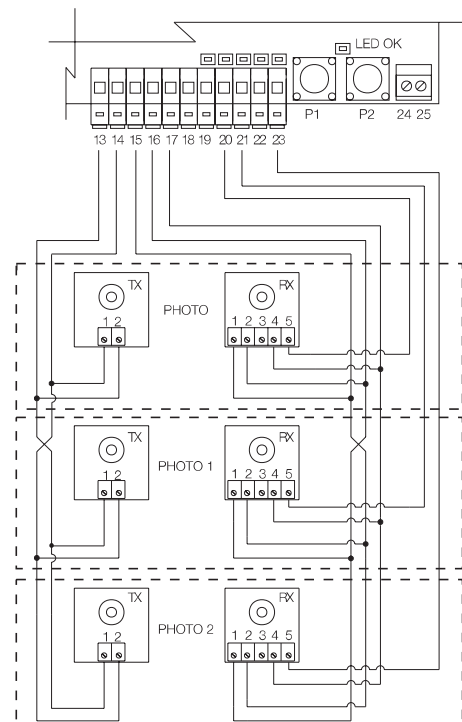

3

Examples of single-wire photocell connections

Connecting the PHOTO photocell only.

(ref. fig. 2)

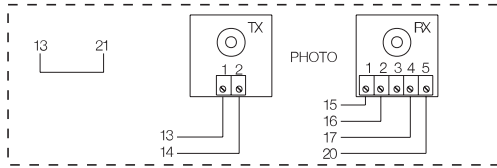

N.B.: The PHOTO1 (21) input is not used and must therefore be connected to terminal 13 in order to allow the PHOTOTEST function to work exclusively with PHOTO.

PHOTO and PHOTO1 connections

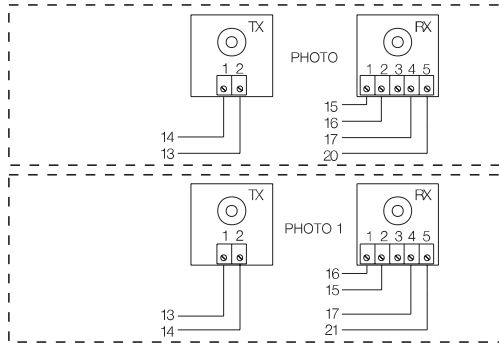

N.B.: observe the indicated power input connections and enable the SYNCHRONISM function (available on all the NICE photocells).

PHOTO, PHOTO1 and PHOTO2 connections

(ref. fig. 3)

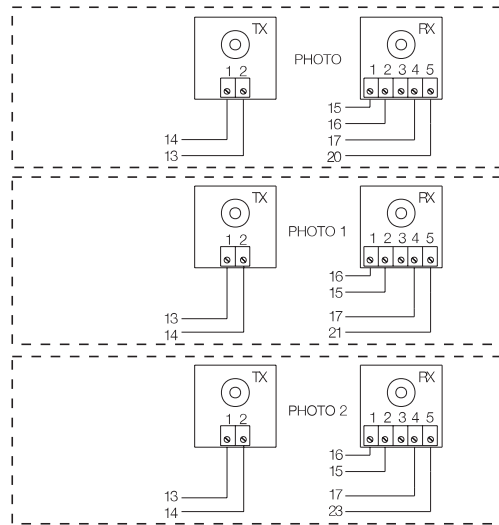

N.B.: observe the indicated power input connections and enable the SYNCHRONISM function (available on all the NICE photocells).

2.4.5) Checking connections

⚠ The next operations involve work being done on live circuits, some parts have mains voltage running through them and are therefore EXTREMELY DANGEROUS! Pay the greatest of attention to what you are doing and NEVER WORK ALONE!

After making connections, the whole system must be checked.

- Power the control unit and check that all the Leds flash rapidly for a few seconds.
- Check that terminals 1-2 are powered and that voltage is about 24Vac on terminals 15-16; if this is not the case, unplug the unit immediately and carefully check the connections and input voltage.
- After the initial rapid flashing, the “OK” Led shows the control unit is working correctly by flashing regularly at 1 second intervals.

When there is a variation in the inputs, the “OK” led flashes rapidly twice to show that the input has been recognised.

- If the connections are correct, the relative Led on the NC inputs, i.e. STOP, PHOTO and PHOTO1 must be on. The STEP-BY-STEP and AUX Leds must be off (if PHOTO2 and AUX are present and programmed correctly, the AUX Led must be on).

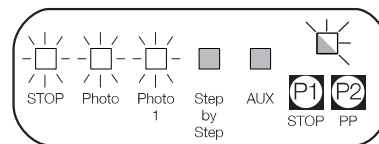

- Make sure that the relative Leds switch on and off when the devices connected to the inputs are operated.

2.5) Searching for mechanical stops

After these checks have been made the control unit can be made to automatically search for the mechanical stops; this operation is required as the A400 control unit must “measure” the duration of the opening and closing manoeuvres.

🔍 If the control unit has never been installed, i.e. there is no valid duration in its memory, the procedure is activated automatically. If this procedure has already been carried out, in order to reactivate it, the memory must first be deleted (see the “Memory programming – deletion” chapter). To find out whether the memory contains duration data, switch power to the unit off and on. If all the Leds flash rapidly for 10 seconds, the memory is empty; if they flash for just 3 seconds, the memory already contains motor work times.

2.5.1) Automatic searching

This procedure is completely automatic and detects the mechanical opening and closing stops by measuring the load on the motors.

 In "particularly difficult" automated systems, the system for detecting the variations in motor current may not work correctly; try changing the current sensitivity device cut-in level or else revert to exclusively timed operation; see the "Search with current sensitivity device disabled" section.

- Before beginning automatic searching, make sure that all the safety devices are enabled (STOP, PHOTO and PHOTO1 active). The procedure will be immediately interrupted if a safety device triggers or a command arrives.
- The doors should preferably be about half open but they may be in any position.
- **Press the PP button to begin the searching phase, comprising:**

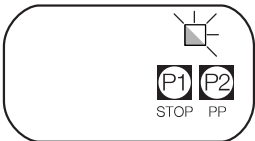

– Motors open briefly, first M2 and then M1.

If the motors do not start during the opening cycle or if the first to move is not M2, press STOP to interrupt the search and check the motor connections.

- Motor M1 closes until the closing mechanical stop is reached.
- Motor M2 closes until the closing mechanical stop is reached.
- Motor M2 begins opening.
- After the programmed delay, motor M1 begins opening.

If the delay is not sufficient, press STOP to interrupt the search and modify the time (see the "Programming" chapter).

- Measurement of the time required for the motors to reach the opening mechanical stops.
- Complete closing manoeuvre.

The motors can start at different times, the aim is to prevent the leaves from shearing by maintaining a suitable delay.

- End of the procedure with memorisation of all time measurements.

All these phases must take place one after the other without any interference from the operator. If this does not happen, the procedure will not continue correctly and must be interrupted with the STOP button. Check the connections and then repeat the procedure, modifying the current sensitivity cut-in thresholds if necessary (see the "Programming" chapter).

2.5.2) Searching with the current sensitivity device disabled

If the current sensitivity device does not work correctly, the control unit can work to timed cycles, totally excluding the current sensitivity function. (to disable the current sensitivity system, see the "Programming parameters and functions" section).

In this case the fitter "tells" the control unit when the mechanical stop has been reached.

- Before beginning searching with the current sensitivity device disabled, make sure that all the safety devices are enabled (STOP, PHOTO and PHOTO1 active).
- The doors should preferably be about half open but they may be in any position.
- **Press the PP button to begin the searching phase, comprising:**

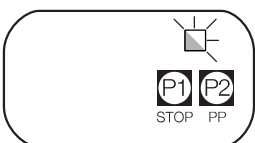

– Brief opening, first M2 and then M1.

If the motors do not start during the opening cycle or if the first to move is not M2, press STOP to interrupt the search and check the motor connections.

– Motor M1 closes until the closing mechanical stop is reached.

- **Press PP when M1 reaches the closing mechanical stop.**

– Motor M2 closes until the closing mechanical stop is reached.

- **Press PP when M2 reaches the closing mechanical stop.**

– After a few moments the M2 motor begins the opening cycle.

- **Press PP when M2 reaches the opening mechanical stop.**

– After a few moments the M1 motor begins the opening cycle.

- **Press PP when M1 reaches the opening mechanical stop.**

– After a few moments a complete closing cycle begins.

The motors can start at different times, the aim is to prevent the leaves from shearing by maintaining a suitable delay.

– End of the procedure with memorisation of all time measurements.

All these phases must take place one after the other; the fitter must only press PP when required. If procedure does not continue correctly, press the STOP button to interrupt it. The procedure will be immediately interrupted if a safety device triggers or a command arrives.

3) Programmable functions

Several functions and parameters of the A400 control unit can be programmed to make the system more suitable to user needs and safer in the various conditions of use.

“Automatic” function:

This function features an automatic closing cycle after the programmed pause time; the pause time is factory set to 20 seconds but it can be modified to 5, 10, 20, 40 or 80 seconds.

“Condominium” function:

This function is useful when the automatic system is radio-commanded by many people. If this function is active, each command received triggers an opening manoeuvre that cannot be interrupted by further commands except for emergency / safety impulses (STOP, PHOTO 1, PHOTO 2) followed by an immediate closing manoeuvre (AUX configured to “Close only”).

Pre-flashing:

This function activates the flashing light before the manoeuvre begins for a time that can be programmed to 2, 4, 6, 8 or 10 seconds.

Close 4 seconds after photo:

During the automatic closing cycle, this function reduces the pause time to 4 seconds after the PHOTO photocell is disengaged, i.e. the gate closes 4 seconds after the user has passed through.

Leaf delay:

During the opening cycle, this function activates the M1 motor at a set time after M2 in order to prevent the doors from getting caught up in each other. This delay is always used in the closing cycle (required by safety regulations) and is automatically calculated by the control unit in order to obtain the same programmed delay for the opening cycle.

Current sensitivity:

The control unit features a system which measures the current absorbed by the two motors and uses this to detect the mechanical stops and any obstacles during gate movement. Given that the absorbed current depends on variable conditions (weight of gate, various kinds of friction, gusts of wind, voltage variations, etc.), the cut-in threshold can be changed.

There are 5 levels: 1 is the most sensitive, 5 is the least sensitive. It is factory set at level 2, a value that should be fine for most installations.

Auxiliary input AUX:

The control unit has an auxiliary input that can be configured in one of the following functions:

- **Type 1 partial opening:** this has the same function as the STEP-BY-STEP input, i.e. it starts motor M2 only. It only works if the gate is completely closed, otherwise it is interpreted as a STEP-BY-STEP command.
- **Type 2 partial opening:** this has the same function as the STEP-BY-STEP input, i.e. it opens the two leafs half the total programmed time. It only works if the gate is completely closed, otherwise it is interpreted as a STEP-BY-STEP command.
- **Open only:** this input carries out the opening manoeuvre only using the Open-Stop-Open-Stop sequence.
- **Close only:** this input carries out the closing manoeuvre only using the Close-Stop-Close-Stop sequence.
- **Photo 2:** performs the function of the “PHOTO 2” safety device.
- **Disabled:** the input has no function.

⚠ The operating principle of the current sensitivity device is based on variations in the current absorbed by the motors; if at the start of the manoeuvre the motor is blocked because the leaf is already at the mechanical stop, there will be no variation in current and the obstacle will therefore not be detected.

⚠ If the “current sensitivity” function (together with other vital features) is suitably adjusted, the system will comply with European standards, EN 12453 and EN 12445, which require techniques or devices to be used to limit force and danger when automatic gates and doors are moved.

 If conditions make it necessary, the current sensitivity function can be disabled and the control unit can work to timed cycles only, see the “Searching with the current sensitivity device disabled” chapter.

⚠ If the current sensitivity function is disabled, the motors continue at “full force” for the whole manoeuvre. Make a careful risks analysis and fit other safety elements to the system, if necessary, to reach the safety levels envisaged by law.

3.1) Pre-set functions

The A4000 control unit features some programmable functions (see the “Programmable functions” chapter) after the search phase. These are initially pre-set in a typical configuration which satisfies most automatic systems.

- Automatic closing : after 20 seconds
- Leaf delay : 4 seconds
- Pre-flashing : disabled
- Auxiliary input : type 1 partial opening
(motor M2 active only)
- Current sensitivity : Level 2

These functions can be changed at any time, both before and after searching, by carrying out a suitable programming procedure.

4) Programming

All the functions described in the “Programmable functions” chapter can be selected by means of a programming phase which terminates by memorising the choices made.

The control unit therefore has a memory which stores the functions and parameters relative to the automation process.

4.1) Delete memory

Each new programme replaces the previous settings, normally it is not necessary to “delete all” the memory. If required, the memory can be totally deleted by performing this simple operation:

⚠ After deleting the memory, a new search must be made for the mechanical stops, while all the functions return to their pre-set values.

Table “A1”	Delete memory:	Example
1.	Disconnect the power supply	
2.	Press and hold down buttons P1 and P2 on the card	
3.	Connect the power supply	
4.	Wait for at least 3 seconds before releasing the two keys	

N.B.: if the memory was deleted correctly, all the Leds will switch off for 1 second.

4.2) Programming methods

Just the two P1 and P2 buttons on the card are used for all programming phases. In this case, the 5 “INPUT” Leds normally indicating the status of the inputs show the selected “parameter”.

There are two different programming levels:

- At level 1, the functions can be activated or deactivated. Each INPUT Led corresponds to a function: if the Led is on, the function is active; if it is off, it is deactivated.

- Led 1 : “Automatic” function
- Led 2 : “Condominium” function
- Led 3 : Pre-flashing
- Led 4 : Close after photo
- Led 5 : Opening delay

- It is possible to switch from level 1 to level 2 where the function parameters can be chosen, each Led corresponds to a different value to associate with the parameter.

Example:

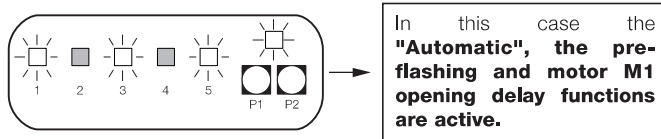





Level 1:				
Led 1 “Automatic” function	Led 2 “Condominium” function	Led 3 Pre-flashing	Led 4 Close 4 seconds after photo	Led 5 Opening delay
↓ ↓ ↓ ↓ ↓				
Level 2:				
Parameter: Pause time	Parameter: AUX input	Parameter: Pre-flashing time	Parameter: Current sensitivity	Parameter: Delay
Led 1 : 5s Led 2 : 10s Led 3 : 20s Led 4 : 40s Led 5 : 80s	Led 1 : Type 1 partial opening Led 2 : Type 2 partial opening Led 3 : Open only Led 4 : Close only Led 5 : Photo 2 Leds off: input disabled	Led 1 : 2s Led 2 : 4s Led 3 : 6s Led 4 : 8s Led 5 : 10s	Led 1 : Level 1 Led 2 : Level 2 Led 3 : Level 3 Led 4 : Level 4 Led 5 : Level 5 Leds off: current sensitivity disabled Level 1 = most sensitive Level 5 = least sensitive	Led 1 : 2s Led 2 : 4s Led 3 : 6s Led 4 : 8s Led 5 : 10s

4.2.1) Level one programming: functions

At level one, the functions can be activated or deactivated. At level one, the OK Led **is always on**, the INPUT Leds indicate which functions are active and which are not.



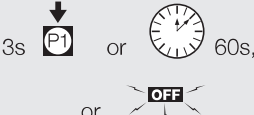



The flashing Led indicates which function is selected, if the Led flashes quickly the function is disabled, if it flashes slowly, the function is enabled.

Table "B1"	Entering level one programming:	Example
1.	Press and hold down buttons P1 and P2 for at least 3 seconds The programming mode has been entered if all the Leds start flashing quickly	
Table "B2"	Activating or deactivating a function:	Example
1.	Press P1 repeatedly until the flashing Led reaches the desired function	
2.	Press P2 to activate or deactivate the function. If the Led flashes quickly the function is disabled, if it flashes slowly, the function is enabled.	
Table "B3"	Exiting level one and saving modifications:	Example
1.	Press and hold down buttons P1 and P2 for at least 3 seconds	
Table "B4"	Exiting level one and cancelling modifications:	Example
1.	Press P1 for at least 3 seconds, or wait 1 minute, or disconnect the power supply	

4.2.2) Level two programming: parameters







At level two the function parameter can be chosen. Level two can only be reached from level one.

At level 2 the OK Led **flashes quickly** while the INPUT Leds indicate the selected parameter.

Table "C1"	Entering level two programming:	Example
1.	Enter level one programming Press (pressing P1 and P2 for at least 3 seconds)	
2.	Select the function by pressing P1 until the flashing Led reaches the desired point	
3.	Enter level two by pressing the P2 button for at least 3 seconds	
Table "C2"	Selecting the parameter:	Example
1.	Press P2 repeatedly until the Led reaches the desired parameter	
Table "C3"	Returning to level one:	Example
1.	Press P1	
Table "C4"	Exiting level one and saving modifications: (also level two modifications)	Example
1.	Press and hold down buttons P1 and P2 for at least 3 seconds	
Table "C5"	Exiting level one and cancelling modifications: (also level two modifications)	Example
1.	Press P1 for at least 3 seconds, or wait 1 minute, or disconnect the power supply	







4.2.3) Example of level one programming

These examples show how to activate or deactivate a level one function, for example, how to activate the “Close after photo” function and deactivate the leaf “Opening delay”.

Example of level one programming: activate the “Close after photo” function and deactivate “Opening delay”		Example
1.	Enter level one programming by pressing P1 and P2 for at least 3 seconds	
2.	Press P1 three times to move the flashing Led to the INPUT N°4 Led (now it flashes quickly)	
3.	Press 2 to activate the “Close after photo” function (now the Led flashes slowly)	
4.	Press P1 once to move the flashing Led to the INPUT N°5 Led (now it flashes slowly)	
5.	Deactivate the “opening delay” function by pressing P2 (now the Led flashes quickly)	
6.	Press P1 and P2 for at least 3 seconds to exit the programming mode and save modifications	

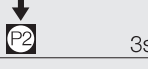
4.2.4) Example of level two programming

This example shows how to modify a level two parameter, for example, how to modify and disable current sensitivity.

Example of level two programming: modifying “current sensitivity”		Example
1.	Enter level one programming by pressing P1 and P2 for at least 3 seconds	
2.	Press P1 three times until the flashing Led reaches the INPUT N°4 Led	
3.	Press P2 for at least 3 seconds to shift to level 2	
4.	Press P2 4 times until all the INPUT Leds are off (current sensitivity disabled)	
5.	Press P1 to return to level one	
6.	Press P1 and P2 for at least 3 seconds to exit the programming mode and save modifications	

4.2.5) Programming diagram

The following figure shows the complete programming diagram of the functions and relative parameters. This figure also shows the functions and parameters as they were initially or following total memory deletion.

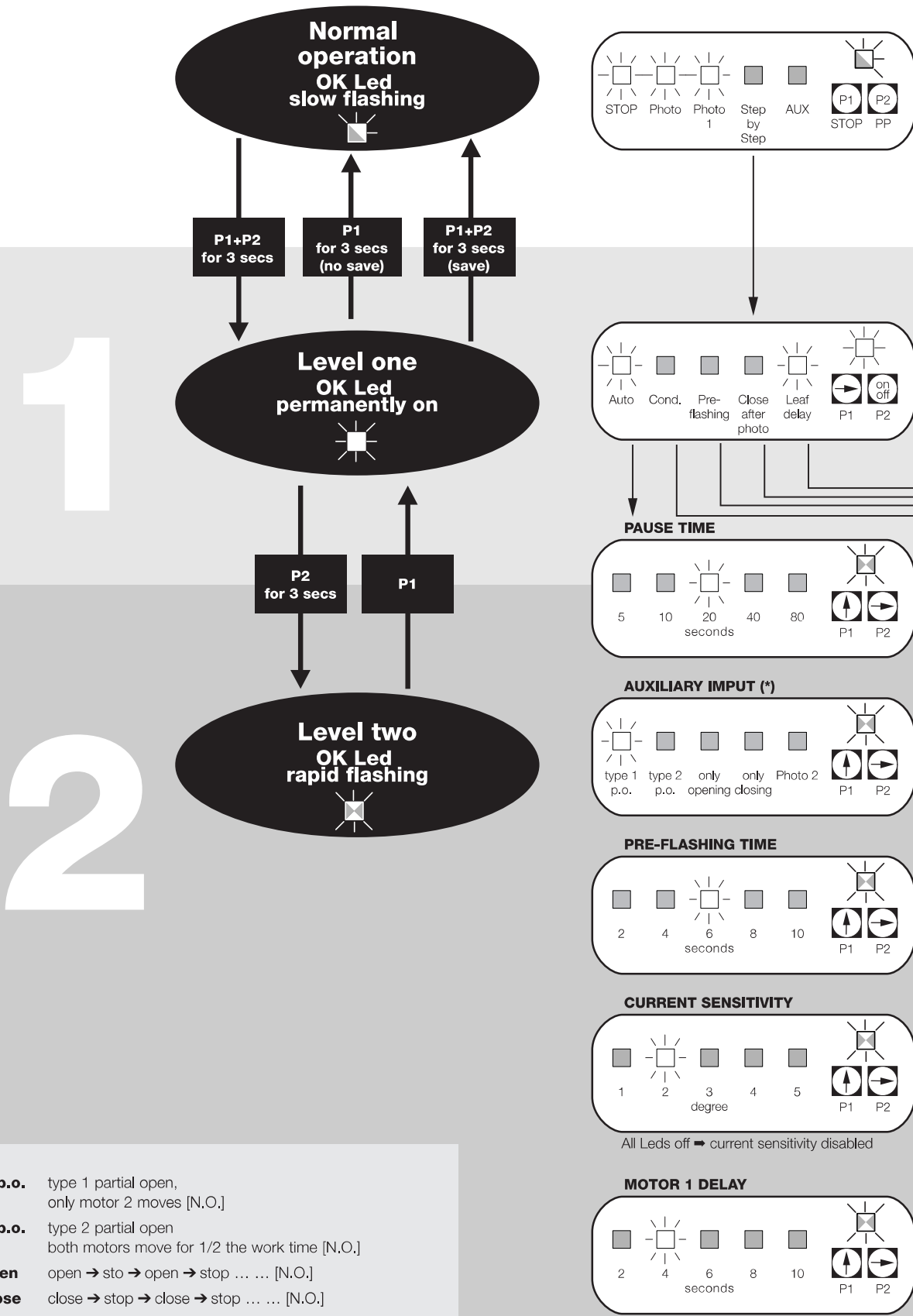

(*)
type 1 p.o. type 1 partial open, only motor 2 moves [N.O.]
type 2 p.o. type 2 partial open both motors move for 1/2 the work time [N.O.]
only open open → sto → open → stop ... [N.O.]
only close close → stop → close → stop ... [N.O.]
photo 2 used as photo 2 [n.c.]

5) Testing

⚠ The automation system must be tested by qualified and expert staff who must establish what tests to perform according to the relative risk.

Testing is the most important part of the whole installation phase. Each single component, e.g. motors, radio receiver, emergency stop, photocells and other safety devices, can require a specific test phase; please follow the procedures shown in the respective instructions manuals.

To test the control unit, carry out the following procedure (the sequence refers to the A400 control unit with pre-set functions).

- Make sure that the activation of the STEP-BY-STEP input generates the following sequence of movements: Open, Stop, Close, Stop.
- Make sure that the activation of the AUX input (type 1 partial opening function) only manages the Open, Stop, Close, Stop sequence of motor 2 while motor 1 remains in the closed position.
- Engage each of the photocells or the other safety devices connected to the PHOTO, PHOTO1 and PHOTO2 inputs and make sure that no manoeuvres are made when a command input is activated
- Perform an opening manoeuvre and check that:
 - the gate continues the opening manoeuvre when PHOTO is engaged.
 - the manoeuvre stops when PHOTO1 is disengaged and only continues when PHOTO1 is disengaged.
 - the manoeuvre stops when PHOTO2 (if installed) is engaged and the closing manoeuvre starts.

- Make sure that the motor switches off when the door reaches the mechanical stop.
- Perform a closing manoeuvre and check that:
 - The manoeuvre stops when PHOTO is engaged and the opening manoeuvre starts.
 - the manoeuvre stops when PHOTO1 is disengaged and the opening manoeuvre starts when PHOTO1 is disengaged.
 - The gate continues the closing manoeuvre when PHOTO2 is engaged.
- Make sure that the stopping devices connected to the STOP input immediately stop all and any movement.
- Check that the level of the obstacle detection system is suitable for the application.
 - During both the opening and the closing manoeuvres, prevent the leaf from moving by simulating an obstacle and check that the manoeuvre inverts before the force indicated by law is exceeded.
- Other checks may be required depending on what devices are connected to the inputs.

 *If an obstacle is detected for 2 consecutive manoeuvres in the same direction, the control unit partially inverts both motors for just 1 second. At the following command, the leafs begin the opening manoeuvre and the first current sensitivity cut-in for each motor is considered as stopping during the opening cycle. The same thing happens when the mains power supply is switched on: the first command is always an opening manoeuvre and the first obstacle is always considered as stopping during the opening cycle.*

6) Optional accessories

RADIO card

The control unit features a connector for plugging in an SM radio card , which activates the “Step-by-Step” and “Aux2” inputs and allows the control unit to be remote-controlled through a transmitter.

output 1	STEP-BY-STEP
output 2	AUX2
output 3	not used
output 4	not used

7) Servicing the A400 control unit

The A400 control unit is an electronic component and therefore needs no particular maintenance. Periodically check, however, at least twice a year, that the whole system is in perfect working order

as indicated in the “Testing” chapter.

7.1) Disposal

This product is made from various kinds of material, some of which can be recycled.

Make sure you recycle or dispose of the product in compliance with current laws and bye-laws.

⚠ Some electronic components may contain polluting substances; do not dump them.

8) What to do if ...

This section will help fitters to solve some of the most common problems that may arise during installation.

No Led is on:

- Check whether the control unit is powered (measure mains voltage at terminals 1-2 and a voltage of 24Vac at terminals 15-16).
- Check the 2 fuses, if not even the OK Led is on or flashing a serious fault has probably occurred and the control unit should therefore be replaced.

The OK Led flashes regularly but the INPUT Leds do not reflect the state of the respective inputs

- Switch off the unit for a moment in order to exit a possible programming phase.
- Carefully check the connections on terminals 13 to 23.

The “Automatic search” procedure does not start.

- The “Automatic search” procedure only starts if it has never been performed before or if the memory has been deleted. To check whether the memory is empty switch off the unit for a moment; when it is switched on again, all the Leds should flash rapidly for 10 seconds. If they flash for only 3 seconds, the memory already contains valid values. If a new “Automatic search” is required, the memory must be totally deleted.

The “Automatic search” procedure has never been performed but it does not start or it behaves incorrectly

- To activate the “Automatic search” procedure the system and all the safety devices must be operative, especially the photocells as they are connected to the “phototest” phase.
- Make sure that no device connected to the inputs cuts in during the “Automatic search” procedure.

- For the “Automatic search” procedure to start correctly, the input Leds must be on as shown, the OK Led must flash once a second.

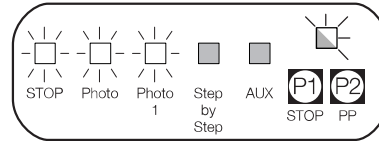

The “Automatic search” procedure was performed correctly but the manoeuvre does not start

- Check that the safety device (STOP, PHOTO, PHOTO1 and, if installed, PHOTO2) Leds are on and that the relative command Led (STEP-BY-STEP or AUX) remains on for the whole duration of the command.

The gate inverts the direction while moving

An inversion is caused by:

- The photocells triggering (PHOTO2 during the opening manoeuvre, PHOTO or PHOTO1 during the closing manoeuvre); in this case, check the connections of the photocells and check the input Leds.
- The current sensitivity device triggering while the motors are moving (not near the mechanical stops, therefore); this is considered as an obstacle and causes an inversion. To find out if the current sensitivity device has triggered, check the OK Led: 1 rapid flash (compared with normal flashing of 1 second) indicates that the current sensitivity device triggered on account of motor M1, 2 rapid flashes indicate that this was caused by motor M2.

9) Technical specifications

Power input	:	A400 control unit → 230 Vac ±10% 50÷60Hz
	:	A400/V1 control unit → 120 Vac ±10% 50÷60Hz
Maximum motor current	:	A400 control unit → 1.2 A (with rotor locked)
	:	A400/V1 control unit → 2.5 A (with rotor locked)
Service power output	:	24 Vac maximum current 150mA
Phototest output	:	24 Vac maximum current 100mA
Flashing lamp output	:	for flashing lamp at mains voltage, maximum power 40 W
Gate open indicator output	:	for indicator lamps at 24 Vac, maximum power 1.5 W
Work time	:	maximum 60 seconds
Pause time	:	programmable at 5, 10, 20, 40, 80 seconds
Leaf delay in open cycle	:	programmable at 2, 4, 6, 8, 10 seconds
Pre-flashing time	:	programmable at 2, 4, 6, 8, 10 seconds
Operating temperature:	:	-20 ÷ 50 °C
Container protected to	:	IP 55
Dimensions and weight	:	230 x 180 h 100 mm, approx. 1100 g

smxi

radio receiver



Description of the product

The special thing about this type of radio receiver is that the recognition code is different for each transmitter (it also changes every time it is used).

Therefore, in order to allow the receiver to recognise a determined transmitter, the recognition code must be memorised. This operation must be repeated for each transmitter required to communicate with the control unit.

 *Up to a maximum of 256 transmitters can be memorised in the receiver. No one transmitter can be cancelled; all the codes must be deleted. - For more advanced functions use the appropriate programming unit.*

During the transmitter code memorisation phase, one of these options may be chosen:

Mode I. Each transmitter button activates the corresponding output in the receiver, that is, button 1 activates output 1, button 2 activates output 2, and so on. In this case there is a single memorisation phase for each transmitter; during this phase, it doesn't matter which button is pressed and just one memory sector is occupied.

Mode II. Each transmitter button can be associated with a particular output in the receiver, e.g., button 1 activates output 2, button 2 activates output 1, and so on. In this case, the transmitter must be memorised, pressing the required button, for each output to activate. Naturally, each button can activate just one output while the same output can be activated by more than one button. One memory section is occupied for each button.

Installing the aerial

The receiver requires an ABF or ABFKIT type aerial to work properly; without an aerial the range is limited to just a few metres. The aerial must be installed as high as possible; if there are metal or reinforced concrete structures nearby you can install the aerial on top. If the cable supplied with the aerial is too short, use a coaxial cable with 50-Ohm impedance (e.g. low dispersion RG58), the cable must be no longer than 10 m.

If the aerial is installed in a place that is not connected to earth (masonry structures), the braid's terminal can be earthed to provide a larger range of action. The earth point must, of course, be local and of good quality. If an ABF or ABFKIT aerial cannot be installed, you can get quite good results using the length of wire supplied with the receiver as the aerial, laying it flat.

Memorising a remote control

⚠ When the memorisation phase is activated, any transmitter correctly recognised within the reception range of the radio is memorised. Consider this aspect with care and remove the aerial if necessary to reduce the capacity of the receiver.

The procedures for memorising the remote controls must be performed within a certain time limit; please read and understand the whole procedure before starting.

In order to carry out the following procedure, it is necessary to use the button located on the box of the radio receiver (reference A, **Fig. 1b**), and the corresponding LED (reference B, **Fig. 1b**) to the left of the button.

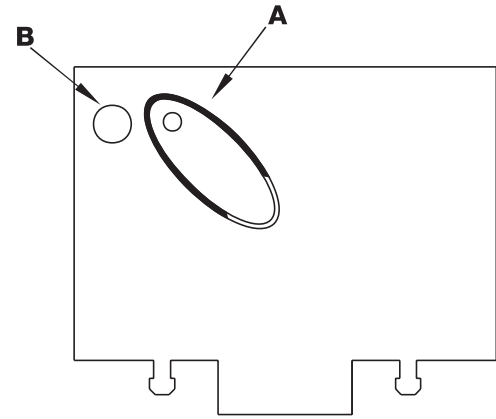

1b

Table "B1"	Mode I memorising (each button activates the corresponding output in the receiver)	Example
1.	Press and hold down the receiver button for at least 3 seconds	3s
2.	Release the button when the Led lights up	
3.	Within 10 seconds press the 1st button on the transmitter to be memorised, holding it down for at least 2 seconds	2s
N.B.: If the procedure was memorised correctly, the Led on the receiver will flash 3 times. If there are other transmitters to memorise, repeat step 3 within another 10 seconds. The memorisation phase finishes if no new codes are received for 10 seconds.		x3

Table "B2"	Mode II memorising (each button can be associated with a particular output)	Example
1.	Press and release the receiver button as many times as the number of the desired output (twice for output no. 2)	
2.	Make sure the Led flashes as many times as the number of the desired output (2 flashes for output no. 2).	
3.	Within 10 seconds press the desired button on the transmitter to be memorised, holding it down for at least 2 seconds.	2s
N.B.: If the procedure was memorised correctly, the Led on the receiver will flash 3 times. If there are other transmitters to memorise, repeat step 3 within another 10 seconds. The memorisation phase finishes if no new codes are received for 10 seconds.		x3

Remote memorising







It is possible to enter a new transmitter in the receiver memory without using the keypad. A previously memorised and operational remote control must be available. The new transmitter will "inherit" the characteristics of the previously memorised one. Therefore, if the first transmitter is memorised in mode I, the new one will also be memorised in mode I and any of the buttons of the transmitter can be pressed. If the first transmitter is memorised in mode II the new one will also be memorised in mode II but the button activating the

required output must be pressed on the first transmitter as must the button required to be memorised on the second. You need to read all the instructions in advance so you can perform the operations in sequence without interruptions. Now, with the two remote controls (the NEW one requiring code memorisation and the OLD one that is already memorised), position yourself within the operating range of the radio controls (within maximum range) and carry out the instructions listed in the table.

Table "B3"	Remote Memorising	Example
1.	Press the button on the NEW transmitter for at least 5 seconds and then release	x5s
2.	Press the button on the OLD transmitter 3 times slowly	1s 1s 1s
3.	Press the button on the NEW transmitter slowly and then release	x1
N.B.: If there are other transmitters to memorise, repeat the above steps for each new transmitter		

Deleting all transmitters

All the memorised codes can be deleted as follows:

Table "B4"	Deleting all transmitters	Example
1.	Press the receiver button and hold it down	
2.	Wait for the Led to light up, then wait for it to switch off and then wait for it to flash 3 times	   x3
3.	Release the button exactly during the third flash	  3°
N.B.: if the procedure was performed correctly, the Led will flash 5 times after a few moments.		 x5

Technical characteristics

Receivers					
	SMXI	SMXIS	SMXIF		
Decoding	Rolling code 52 bit FLOR	Rolling code 64 bit SMILO	1024 FLO combinations		
Frequency	433.92MHz				
Input impedance	52ohm				
Outputs	4 (on connector SMXI)				
Sensitivity	better than 0.5µV				
Working temp.	-20°C ÷ + 50°C				
Transmitters					
	FLOR	VERY VR	FLO	VERY VE	SMILO
Buttons	1 - 2 - 4	2	1 - 2 - 4	2	2 - 4
Power input	12Vdc Batt. 23A	6Vdc lithium batt.	12Vdc Batt. 23°	6Vdc lithium batt.	12Vdc Batt. 23A
Absorption	10mA	10mA	15mA	10mA	25mA
Frequency	433.92MHz				
Working temp.	-40°C ÷ + 85°C				
Radiated power	100µW				